

Flat

VIBIA

5922

Design By Ichiro Iwasaki

Flat is a large ceiling lamp composed of horizontal discs at various heights that create planes of reflected light. The plates are self-illuminated by reflected light. The Flat ceiling light has a strong graphic quality, combining structure and functionality.

Model Sheet

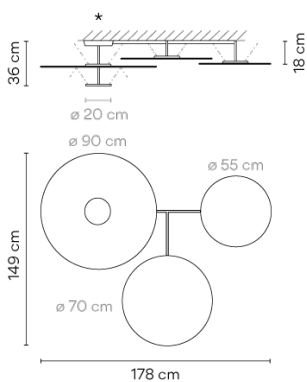

Finish

- 10 White
NCS S 0300-N
- 71 White, Green L1, Off-White
NCS S 0300-N, NCS S 4005-G80Y, NCS S 4005-G80Y

LED temperature color 2700 K

Dimming DALI 1-10V Push
Optional Casambi
Min. quantity, upcharge and extra lead time apply [EN]

Installation type Surface Canopy





Materials

- Ceiling rose: Steel
- Reflector: Aluminum
- Body: Steel
- Head: Aluminium

Light source 4 x LED PLATE 25W 700mA
D

LED CRI>90 13920 lm 139.2
2700 K

Driver CC - Constant Current 700
220~240 V 50/60 HZ

  **Dimmable** **LED**
  **IP20** **50-60Hz**

Application Ceiling Lamps

Packaging

- 1 Box
- 1.275 m x 1.06 m x 0.46 m
- Gross weight 26.6
- Net weight 19.98
- Vol. 0.6216

Lighting effect

General Lighting

Lamp that emits an upward or backward beam that is reflected by the ceiling or wall.

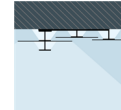

Photometric Data

Efficiency 90.66 lm/W
Coordinate System CG
Total Flux 9863.64 lm
Maximum Value 3196.80 cd

Other Applications

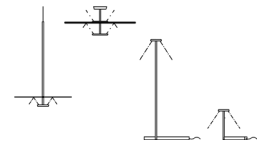

All of our products come with a five-year warranty.
Check our legal terms at www.vibia.com/warranty

Vibia Lighting, S.L.U.

Office / Oficina
Progrés 4-6, 08850 Gavà, Barcelona, Spain.

International T +34 934 796 971
Spain / Portugal T +34 934 796 970

customer.service@vibia.com
vibia.com